

WAECO

mobile solutions

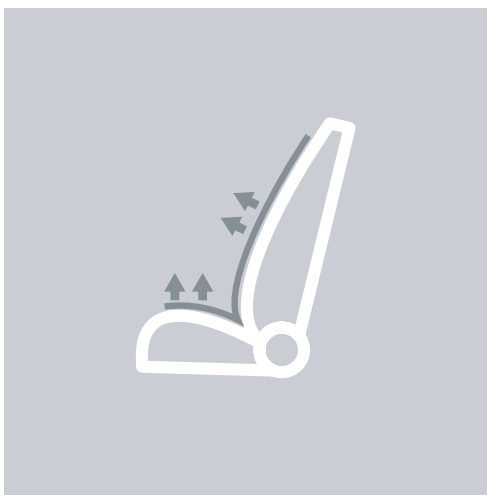

MagicComfort MSH50

D 7 Nachrüstbare Einbau-Sitzheizung
Montage- und Bedienungsanleitung

GB 15 Retrofit insert seat heater
Installation and Operating Instructions

E 23 Calefacción del asiento como aditamento adicional
Instrucciones de montaje y de servicio

F 31 Chauffage de siège, montage ultérieur
Instructions de montage et de service

I 39 Riscaldamento sedili addizionale
Istruzioni di montaggio e d'uso

NL 47 In te bouwen stoelverwarming
Montage- en bedieningshandleiding

DK 55 Sædevarme til eftermontering
Monterings- og betjeningsvejledning

S 63 Stolvärmeanordning för montering i efterhand
Monterings- och bruksanvisning

N 71 Ettermonterbar setevarmer
Monterings- og bruksanvisning

FIN 79 Jälkikäteen asennettava istuinlämmitys
Asennus- ja käyttöohje

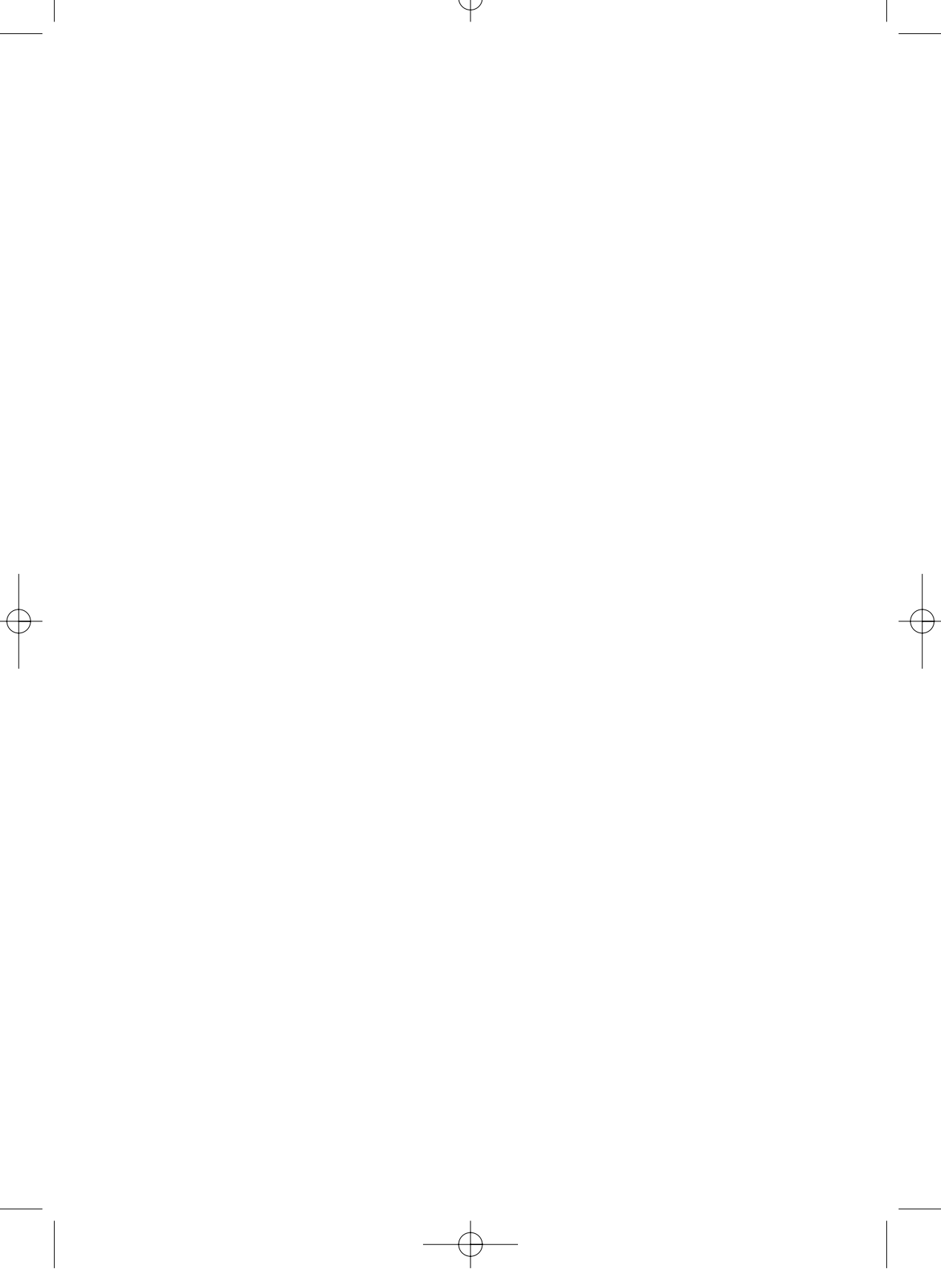

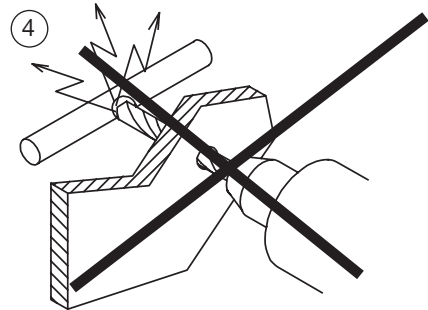
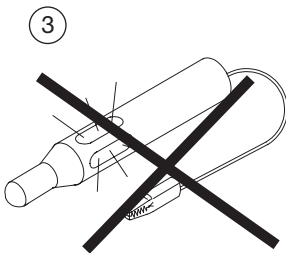
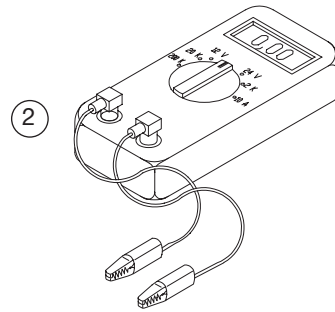
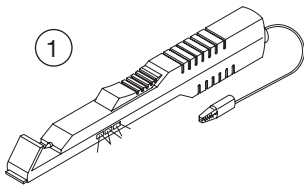
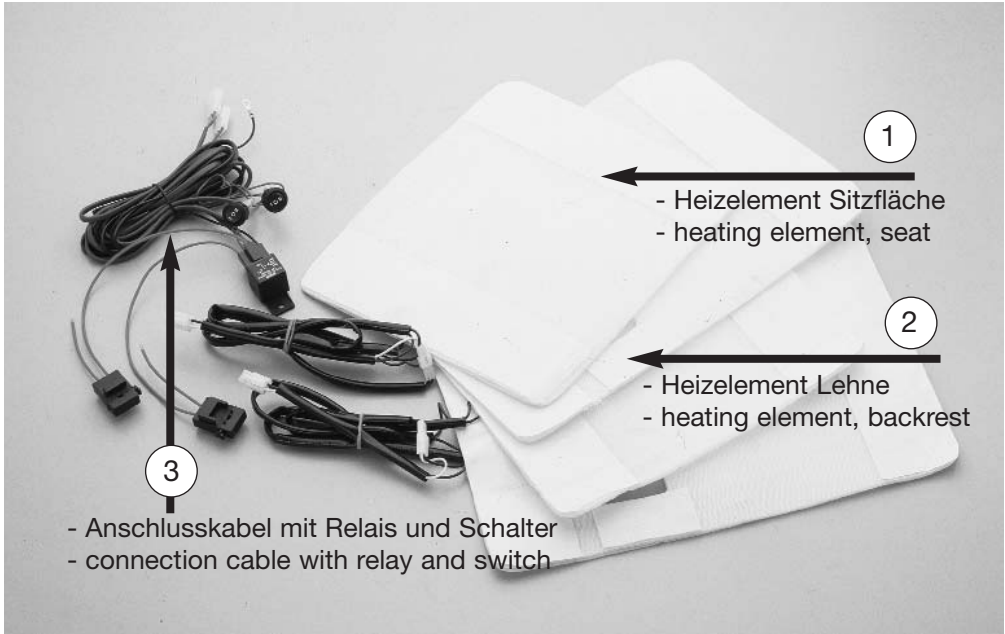

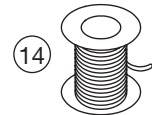
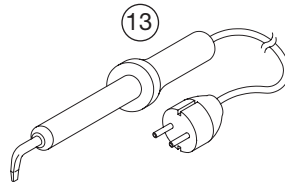
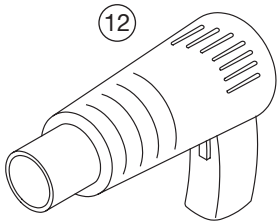
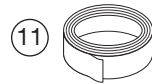
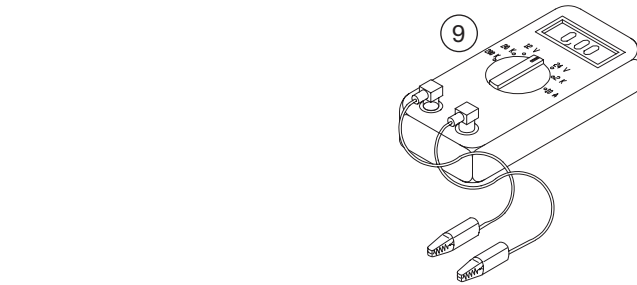
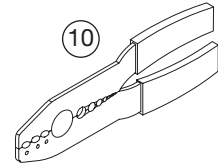
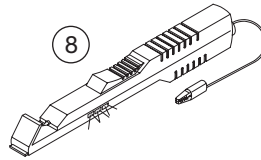
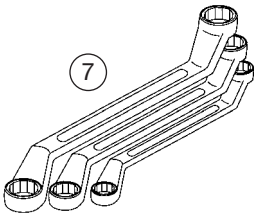
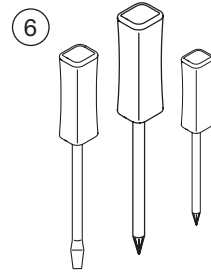
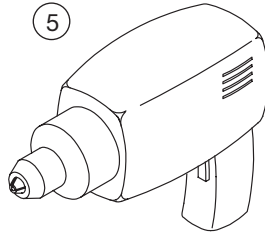
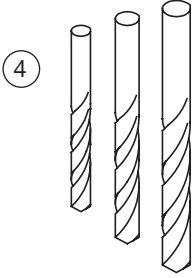
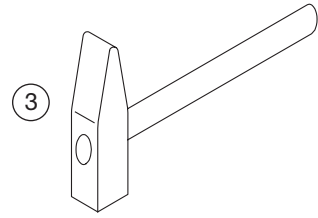
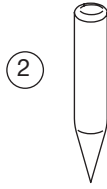
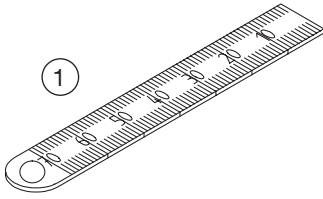

1



2



3



4



5



6



7

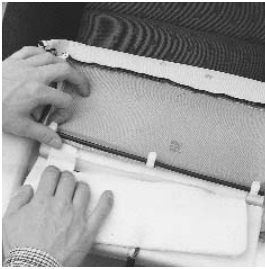

8



9



10



11

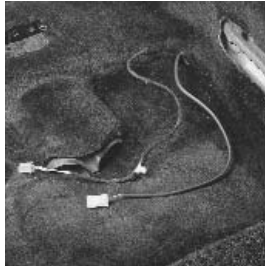

12



1

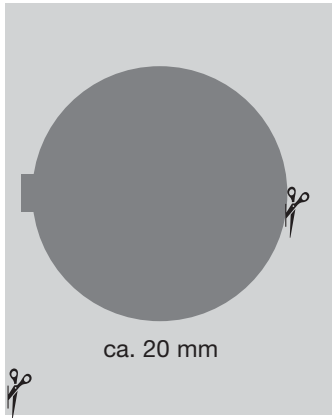

2

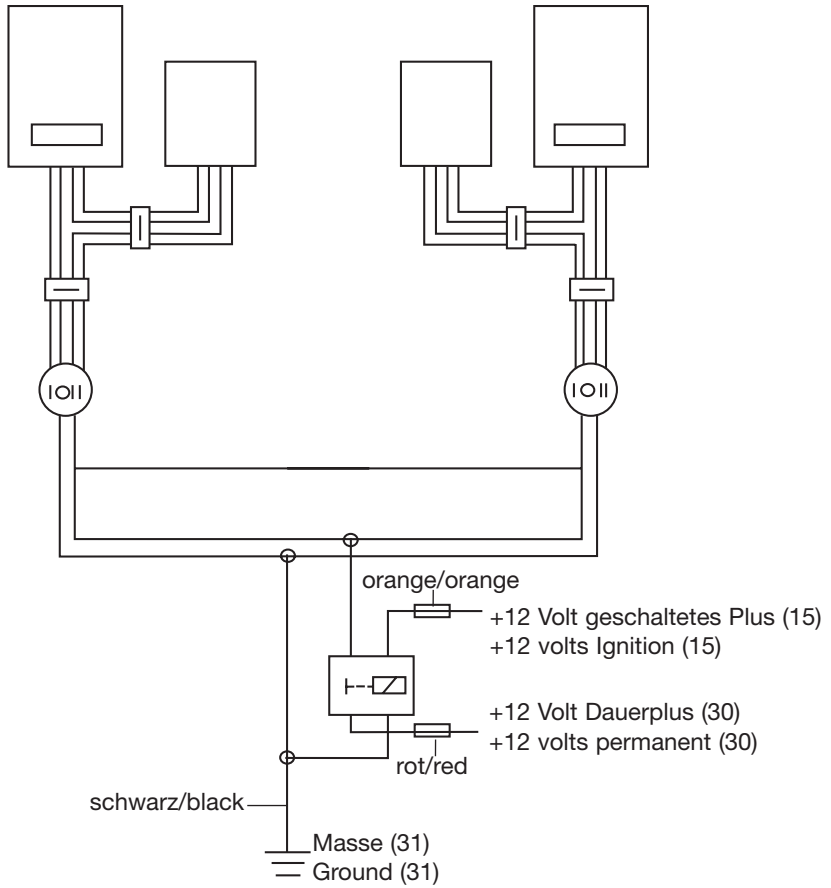

6

Table of contents

General product description	15
Information on using the installation instructions	15
General safety and installation instructions	15-18
Scope of delivery	18
Required tools	18
Installing the seat heating	19-20
Technical data	21
Disposal instructions	21

General product description

The WAECO MagicHeat seat heating is a convenience product intended for the installation in the vehicle seats. The shape of the seats is not modified by the heating elements. The seat heating is operated by separate switches for the driver and passenger seats. The comfortable warmth can be felt within a short period of time.

Information on using the installation instructions



Warning! Safety instruction:

Failure to observe these warnings may result in injuries to persons or damage to material.

- ◆ The rhombus marks installation steps which you have to implement.

To ensure a problem-free installation, read these assembly and operating instructions carefully before starting the installation.

Hand over the assembly and operating instructions when passing on the MSH-50 to a new proprietor.

If the operating instructions do not answer all your questions, or if the assembly steps are not clear, please do not hesitate to contact our customer technical support service.

Safety and installation instructions



The respective manufacturer's specifications are to be observed with respect to all works you carry out.

The relevant specifications of the respective vehicle manufacturer have to be observed with respect to vehicles that are equipped with side airbags in the seat backrests, a seat occupation detection, or a child seat detection system.



Warning! Inadequate cable connections can lead to short-circuits which cause the following:

- cable fires
- activation of the airbag
- damage to electronic control equipment
- electrical functions (blinkers, brake lights, horn, ignition, lights) fail.



The following indications must be therefore considered: With respect to works on the lines of the vehicle the following terminal designations apply:

- 30** (input from battery plus direct),
- 15** (switched plus, behind battery)
- 31** (return cable from battery, earth)

The securest form of connection is obtained by **soldering** the cable ends **and then insulating the connection**.

For detachable connections, only use insulated cable brackets, connector plugs, and flat pin bushings. Do not use crimp connections (line connectors) or luster terminals.

Use crimp pliers for connecting the cables with cable lugs, plugs, or flat pin bushings.

For cable connections to 31 (ground):

Screw the cable with a cable lug and toothed washer to a vehicle's own ground bolt or screw it with a cable lug, sheet metal screw, and toothed-washer to the car body sheet.

Always ensure a good earthing connection!

Safety and installation instructions



Caution! To check the voltage in electrical cables, use only a diode test lamp (see B 1) or a voltmeter (see B 2). Test lamps (see B3) which light up consume too much current and the vehicle electronics may be damaged.



Caution! In order to avoid damages, please make sure that there is sufficient free space for the drill outlet (see B4). Every drill hole must be deburred and treated with a rust preventing agent.



Warning! Due to risk of short-circuiting, always disconnect the negative pole of the battery prior to any works on the electrical equipment of the vehicle. In case of vehicles with a supplementary battery, also disconnect this negative pole.



Caution! When disconnecting the negative terminal of the battery, all volatile memories of the convenience electronics lose their stored data. Depending on the vehicle equipment, the following data may need to be reprogrammed:
Radio code, vehicle clock, time switch clock, on-board computer, seat position

Instructions on how to set these values can be found in the relevant operating instructions.



Warning! The components of the device which are inside the vehicle must be securely fixed so that they cannot come loose and **injure the vehicle's occupants under any circumstances (sudden braking, traffic accident).**

Sharp and heavy objects must not be placed on the seat as the seat heating may be damaged otherwise. For persons with a disturbed heatsensation, it is recommended to operate the MagicHeat only on level I. If the seat heating is turned on, no heat insulating objects, such as blankets or coats, must be placed on the seat. The seat heating may be damaged by spilled liquids on the seat. Never turn on the seat heating if the seat is wet.

Safety and installation instructions



Caution! WAECO International does not accept any liability for damages due to the following:

- a) Assembly errors
- b) Damages to the system caused by mechanical effects and overvoltages
- c) Modifications of the device without the express approval of WAECO International
- d) Use for any purposes other than those described in the assembly instructions.

Scope of delivery

No.	Quantity	Designation	Item no.
1	2	Heating element, seat (see A1)	MSH-S-50
2	2	Heating element, backrest (see A2)	MSH-L-50
3	1	Connecting cable w/ relay and switch (see A3)	MSH-KA-50
4	4	Double-sided adhesive tape	

Required tools

The following is required for the installation:

- meter rule (see C 1)
- prick punch (see C 2)
- hammer (see C 3)
- drill bits (see C 4)
- drilling machine (see C 5)
- screwdriver (see C 6)
- wrench (see C 7)

The following is required for the electrical connection and testing:

- diode test lamp (see C 8)
or voltmeter (see C 9)
- crimp pliers (see C 10)
- insulation tape (see C 11)
- electric hair drier (see C 12)
- hatchet iron (see C 13)
- soldering tin (see C 14)

Depending on your individual assembly, you may need other screws, nuts, washers, metal screws and cable clips than those contained in the scope of delivery.

Installation

1. Removing the seats. The vehicle must be secured to ensure it cannot roll away during the installation of the seat heating. With respect to vehicles with side airbags in the seat backrest, the manufacturer's specifications regarding the disassembly of the seats and upholstery must be observed. Once you have checked the installability (based on the present installation instruction and the manufacturer information), the vehicle seats should be removed. To do so, loosen the fastening screws, and lift the seat out of the vehicle.
2. Remove all plastic coverings of the seat to have free access to the fastening of the cover fabric.
3. Separate the backrest from the seat (see D 1 and D 2)
4. Open the seat cover. In most cases, the cover fabric is squeezed into a groove on the underframe by means of a wide piece of cardboard or a metal wire. The fastening can be loosened using a screwdriver and a pair of pliers (see D 3 and D 4).
5. Loosen any existing upholstery clips or cross struts (see D 5)
6. Now, the heating element for the seat can be inserted between the cover fabric and the foam core of the seat (see D 6).

The heating element of the seat surface provides of a recess to bridge the stitched sections or the cross struts that are used as an additional fastening of the seat cover on the foam core. Depending on the type of seat, this area can be led through the stitched section (see D 7) or placed into the cross strut tunnel through cut-outs. Fix the heating elements with double-sided adhesive tape to prevent them from slipping away on the foam core. Please make sure that there are no folds or bends.

Installation



CAUTION! If you have to perform cuts in the heating element, please consider the course of the heating lines. These lines must not be damaged or extremely bent.

7. The steps for the installation of the heating element into the backrest are the same as for the installation into the seat.
8. The cover of the backrest can be opened in the lower part (see D 8).

9. The heating element is inserted in the gap between the seatcover and the upholstery and fixed with double-sided adhesive tape (avoid folds)(see D 9)

The heating surface only has to cover the seat surface for approximately 30-35 cm as the driver only leans against this area in a normal seating position. If the seats are equipped with side airbags, the cover fabric provides of break-off points. Thus, the seat cover must not be excessively pulled or moved.

10. Electrical connection

Find a suitable place of installation for the seat heating switches. If possible, existing blind caps should be used. Please make sure that the space behind the covering is sufficient for the installation of the switch.

Mark the switch cut-out using the delivered template. Cut out the marked area using the appropriate tool. (see E 1)

Install the prepared cable harness, and make sure the cables cannot get bent or worn through(see D 11).

Particularly in the area of the seat guide rails a proper installation of the cables must be ensured. For more information on the electrical connection (see E 2).

Technical data

Operating voltage:	12 volts
Current consumption:	1. level 1.87 A per seat 2. level 3.75 A per seat
Dimensions:	Seat element 400 x 280 mm Backrest element 300 x 280 mm

Disposal instruction

Please note that electrical units contain many recyclable materials as well as environmentally hazardous components. Please take care in your own interest and for the sake of the environment that such components are only disposed of in a proper and admissible manner.

